

**SURGICAL
TECHNIQUE**

PRECISION SPINE
SHURFIT® 3D
TITANIUM INTERBODY CAGES

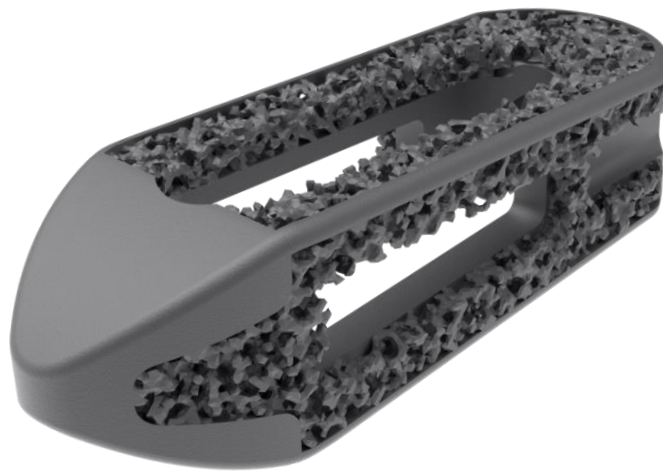

PRECISION SPINE®
Discover the Difference



TABLE OF CONTENTS

ShurFit® 3D Titanium STRAIGHT Interbody Fusion Devices

OVERVIEW	3
IMPLANT SPECIFICATIONS	5
INSTRUMENTS	8
SURGICAL TECHNIQUE	13
<i>Patient Positioning</i>	13
<i>Endplate Preparation</i>	14
<i>Implant Selection</i>	15
<i>Implant Insertion</i>	16
<i>Implant Removal</i>	18

SHURFIT® 3D Ti STRAIGHT INTERBODY SYSTEM

OVERVIEW

The ShurFit 3D Titanium Interbody Fusion Devices consist of implants with various heights and lengths to accommodate individual patient anatomy. The device is intended to provide mechanical support to the implanted level until biologic fusion is achieved. All components are manufactured from Ti-6AL-4V. All implants are supplied clean and "STERILE".

PRODUCT HIGHLIGHTS

- 3D Ti Structure
- Open Windows Coupled with 60% Porosity
- Interconnected Lattice Structure
- Internal Struts
- Large Graft Window
- Bulleted Leading Edge
- Multiple Lordotic Options

INDICATIONS

The ShurFit 3D Titanium Interbody Fusion Devices are indicated for intervertebral body fusion of the spine in skeletally mature patients. The device system is designed for use with autograft to facilitate fusion. One device is used per intervertebral space for the 26mm and 28mm 3D Ti systems. Two devices are used per intervertebral space for the 22mm and 24mm 3D Ti system.

The ShurFit 3D Titanium Interbody Fusion Devices are intended for use at either one level or two contiguous levels in the lumbar spine, from L2 to S1, for the treatment of degenerative disc disease (DDD) with up to Grade I spondylolisthesis. DDD is defined as back pain of discogenic origin with degeneration of the disc confirmed by history and radiographic studies. The lumbar device is to be used with supplemental fixation and autogenous autograft. Patients should have at least six months of non-operative treatment prior to treatment with a lumbar intervertebral fusion device.

Please refer to package insert (LBL-IFU-034 Rev A) for complete system description, indications and warnings.

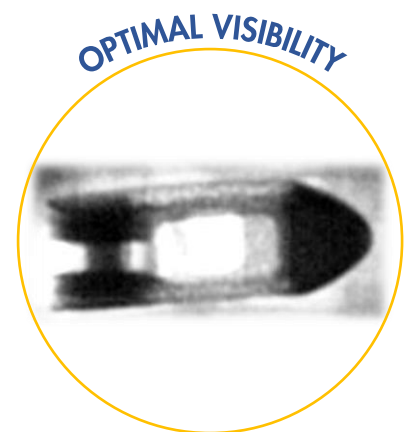
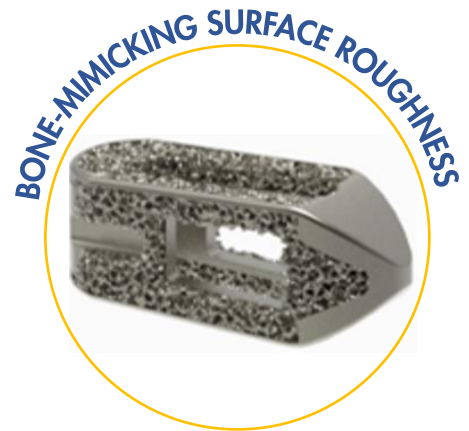

SHURFIT® 3D Ti STRAIGHT INTERBODY SYSTEM

OVERVIEW

3D Ti Structure with Interconnected Lattice to help facilitate bony integration and reduce risk of migration

- Pore Size Range: 100 - 800µm
- Avg. Pore Size: 600µm

Open Windows Coupled with Reduced Density (~60% porosity) enhances intraoperative imaging and fusion assessment

Lattice Structure decreases cage stiffness reducing the risk of subsidence

Internal Struts increases overall support and allows for insert and rotate cage positioning

Large Window provides maximize bone graft material

Bulleted Leading Edge allows for ease of insertion

Multiple Lordotic Options accommodates varying patient anatomies

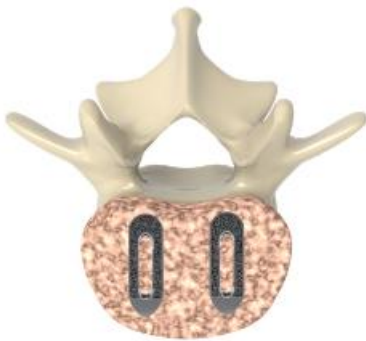
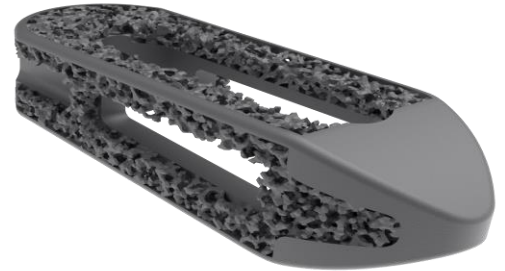

PLIF Interbody Cage

Length: 22, 24mm
Width: 9mm
Lordosis: 0°, 6° & 12°
Heights: 8-14mm (1mm) *

* Depending on lordosis

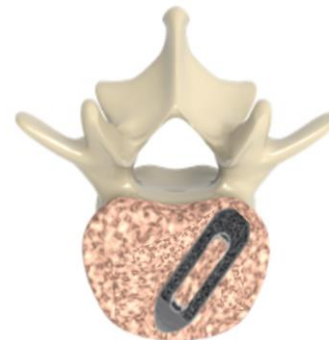

TLIF Interbody Straight Cage

Length: 26, 28mm
Width: 9mm
Lordosis: 0°, 6° & 12°
Heights: 8-14mm (1mm) *

* Depending on lordosis

SHURFIT® LUMBAR STRAIGHT IMPLANT CASE

72-BK-0041

PRECISION SPINE
SHURFIT® 3D
 TITANIUM INTERBODY CAGES

72-BK-0041
 3D Ti Straight Cage Kit
 22mm and 24mm Lengths

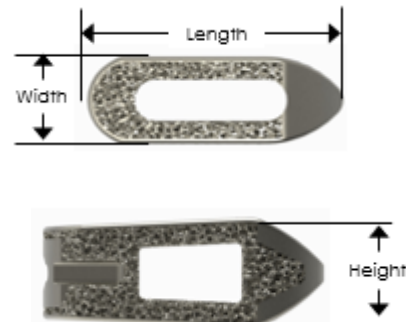

Precision Spine, Inc.
 2050 Executive Drive, Pearl, MS 39208
 Customer Service: 1.888.241.4773
 Phone: 601.420.4244
 Toll Free: 877.780.4370
 Fax: 601.420.5501
 www.precisionspineinc.com

PRECISION SPINE®

LBL-AW-141 Rev. A

Item No.	Description	Qty	Item No.	Description	Qty
72-STB-2208	3D Ti Straight Cage; 22 x 08mm 6°	4	72-STB-2408	3D Ti Straight Cage; 24 x 08mm 6°	4
72-STB-2209	3D Ti Straight Cage; 22 x 09mm 6°	4	72-STB-2409	3D Ti Straight Cage; 24 x 09mm 6°	4
72-STB-2210	3D Ti Straight Cage; 22 x 10mm 6°	4	72-STB-2410	3D Ti Straight Cage; 24 x 10mm 6°	4
72-STB-2211	3D Ti Straight Cage; 22 x 11mm 6°	4	72-STB-2411	3D Ti Straight Cage; 24 x 11mm 6°	4
72-STB-2212	3D Ti Straight Cage; 22 x 12mm 6°	4	72-STB-2412	3D Ti Straight Cage; 24 x 12mm 6°	4
72-STB-2213	3D Ti Straight Cage; 22 x 13mm 6°	4	72-STB-2413	3D Ti Straight Cage; 24 x 13mm 6°	4
72-STB-2214	3D Ti Straight Cage; 22 x 14mm 6°	4	72-STB-2414	3D Ti Straight Cage; 24 x 14mm 6°	4
72-STC-2209	3D Ti Straight Cage; 22 x 09mm 12°	4	72-STC-2410	3D Ti Straight Cage; 24 x 10mm 12°	4
72-STC-2210	3D Ti Straight Cage; 22 x 10mm 12°	4	72-STC-2411	3D Ti Straight Cage; 24 x 11mm 12°	4
72-STC-2211	3D Ti Straight Cage; 22 x 11mm 12°	4	72-STC-2412	3D Ti Straight Cage; 24 x 12mm 12°	4
72-STC-2212	3D Ti Straight Cage; 22 x 12mm 12°	4	72-STC-2413	3D Ti Straight Cage; 24 x 13mm 12°	4
72-STC-2213	3D Ti Straight Cage; 22 x 13mm 12°	4	72-STC-2414	3D Ti Straight Cage; 24 x 14mm 12°	4
72-STC-2214	3D Ti Straight Cage; 22 x 14mm 12°	4			

ShurFit 3D Ti Interbody Cages are provided in a sterile package. Carefully confirm the implant size that you desire from the outside label prior to opening the box or inside trays. The implants are packaged in a double-tray with a peel back lid for easy transfer into the sterile field. If the implant is opened and not used, the implant MAY NOT be sterilized and used again.

SHURFIT® LUMBAR STRAIGHT IMPLANT CASE

72-BK-0040



SHURFIT[®] 3D

TITANIUM INTERBODY CAGES

72-BK-0040

3D Ti Straight Cage Kit

24mm and 26mm Lengths

Precision Spine, Inc.
 2050 Executive Drive, Pearl, MS 39208
 Customer Service: 1.888.241.4773
 Phone: 601.420.4244
 Toll Free: 877.780.4370
 Fax: 601.420.5501
www.precisionspineinc.com



LBL-AW-139 Rev. A

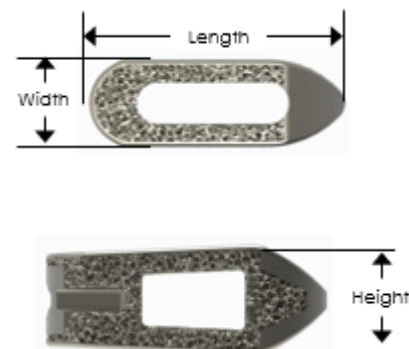

Item No.	Description	Qty	Item No.	Description	Qty
72-STB-2408	3D Ti Straight Cage; 24 x 08mm 6°	4	72-STB-2608	3D Ti Straight Cage; 26 x 08mm 6°	4
72-STB-2409	3D Ti Straight Cage; 24 x 09mm 6°	4	72-STB-2609	3D Ti Straight Cage; 26 x 09mm 6°	4
72-STB-2410	3D Ti Straight Cage; 24 x 10mm 6°	4	72-STB-2610	3D Ti Straight Cage; 26 x 10mm 6°	4
72-STB-2411	3D Ti Straight Cage; 24 x 11mm 6°	4	72-STB-2611	3D Ti Straight Cage; 26 x 11mm 6°	4
72-STB-2412	3D Ti Straight Cage; 24 x 12mm 6°	4	72-STB-2612	3D Ti Straight Cage; 26 x 12mm 6°	4
72-STB-2413	3D Ti Straight Cage; 24 x 13mm 6°	4	72-STB-2613	3D Ti Straight Cage; 26 x 13mm 6°	4
72-STB-2414	3D Ti Straight Cage; 24 x 14mm 6°	4	72-STB-2614	3D Ti Straight Cage; 26 x 14mm 6°	4
72-STC-2410	3D Ti Straight Cage; 24 x 10mm 12°	4	72-STC-2610	3D Ti Straight Cage; 26 x 10mm 12°	4
72-STC-2411	3D Ti Straight Cage; 24 x 11mm 12°	4	72-STC-2611	3D Ti Straight Cage; 26 x 11mm 12°	4
72-STC-2412	3D Ti Straight Cage; 24 x 12mm 12°	4	72-STC-2612	3D Ti Straight Cage; 26 x 12mm 12°	4
72-STC-2413	3D Ti Straight Cage; 24 x 13mm 12°	4	72-STC-2613	3D Ti Straight Cage; 26 x 13mm 12°	4
72-STC-2414	3D Ti Straight Cage; 24 x 14mm 12°	4	72-STC-2614	3D Ti Straight Cage; 26 x 14mm 12°	4

ShurFit 3D Ti Interbody Cages are provided in a sterile package. Carefully confirm the implant size that you desire from the outside label prior to opening the box or inside trays. The implants are packaged in a double-tray with a peel back lid for easy transfer into the sterile field. If the implant is opened and not used, the implant MAY NOT be sterilized and used again.

SHURFIT® LUMBAR STRAIGHT IMPLANT CASE

72-BK-0042

PRECISION SPINE
SHURFIT® 3D
 TITANIUM INTERBODY CAGES

72-BK-0042
 3D Ti Straight Cage Kit
 26mm and 28mm Lengths

Precision Spine, Inc.
 2050 Executive Drive, Pearl, MS 39208
 Customer Service: 1.888.241.4773
 Phone: 601.420.4244
 Toll Free: 877.780.4370
 Fax: 601.420.5501
 www.precisionspineinc.com

PRECISION SPINE®

LBL-AW-143 Rev. A

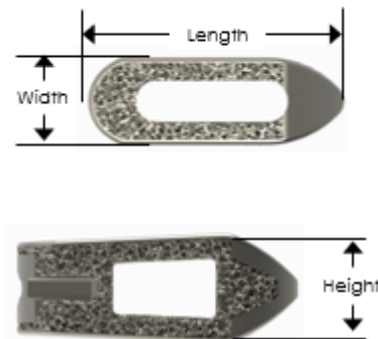

Item No.	Description	Qty	Item No.	Description	Qty
72-STB-2608	3D Ti Straight Cage; 26 x 08mm 6°	4	72-STB-2808	3D Ti Straight Cage; 28 x 08mm 6°	3
72-STB-2609	3D Ti Straight Cage; 26 x 09mm 6°	4	72-STB-2809	3D Ti Straight Cage; 28 x 09mm 6°	3
72-STB-2610	3D Ti Straight Cage; 26 x 10mm 6°	4	72-STB-2810	3D Ti Straight Cage; 28 x 10mm 6°	3
72-STB-2611	3D Ti Straight Cage; 26 x 11mm 6°	4	72-STB-2811	3D Ti Straight Cage; 28 x 11mm 6°	3
72-STB-2612	3D Ti Straight Cage; 26 x 12mm 6°	4	72-STB-2812	3D Ti Straight Cage; 28 x 12mm 6°	3
72-STB-2613	3D Ti Straight Cage; 26 x 13mm 6°	4	72-STB-2813	3D Ti Straight Cage; 28 x 13mm 6°	3
72-STB-2614	3D Ti Straight Cage; 26 x 14mm 6°	4	72-STB-2814	3D Ti Straight Cage; 28 x 14mm 6°	3
72-STC-2610	3D Ti Straight Cage; 26 x 10mm 12°	4	72-STC-2810	3D Ti Straight Cage; 28 x 10mm 12°	3
72-STC-2611	3D Ti Straight Cage; 26 x 11mm 12°	4	72-STC-2811	3D Ti Straight Cage; 28 x 11mm 12°	3
72-STC-2612	3D Ti Straight Cage; 26 x 12mm 12°	4	72-STC-2812	3D Ti Straight Cage; 28 x 12mm 12°	3
72-STC-2613	3D Ti Straight Cage; 26 x 13mm 12°	4	72-STC-2813	3D Ti Straight Cage; 28 x 13mm 12°	3
72-STC-2614	3D Ti Straight Cage; 26 x 14mm 12°	4	72-STC-2814	3D Ti Straight Cage; 28 x 14mm 12°	3

ShurFit 3D Ti Interbody Cages are provided in a sterile package. Carefully confirm the implant size that you desire from the outside label prior to opening the box or inside trays. The implants are packaged in a double-tray with a peel back lid for easy transfer into the sterile field. If the implant is opened and not used, the implant MAY NOT be sterilized and used again.

SHURFIT® LUMBAR STRAIGHT INSTRUMENT TRAY

72-BK-070X

Top Level

1-9
Upper Level

10-19
Lower Level

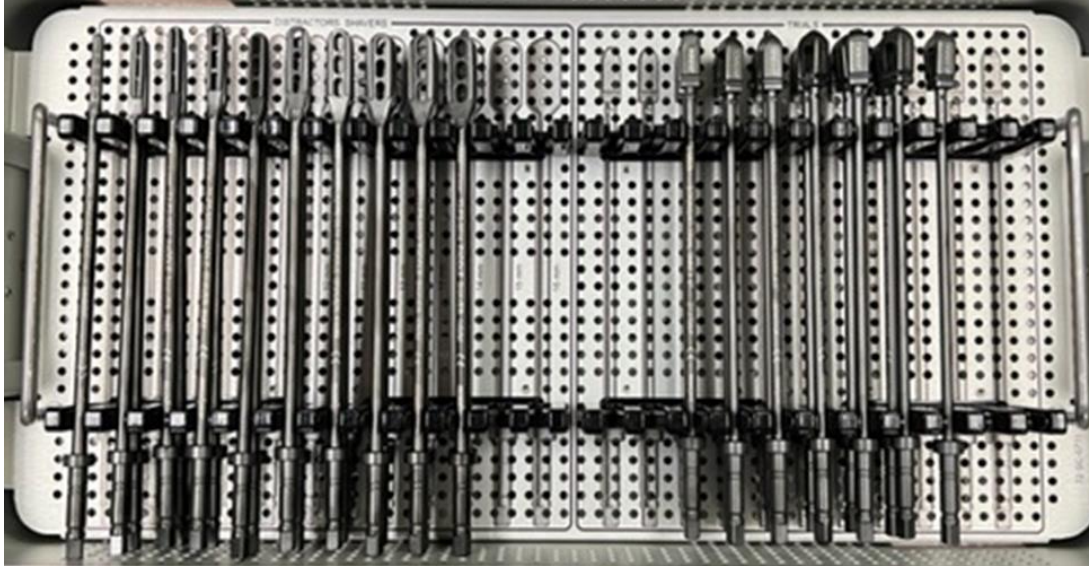

20-26
Upper Level

27-32
Lower Level

#	Item No.	Description	Qty	#	Item No.	Description	Qty
1	72-PS-9506	Paddle Shaver, 6mm	1	20	72-TS-0608	Straight Cage Trial, 8mm x 6°	1
2	72-PS-9507	Paddle Shaver, 7mm	1	21	72-TS-0609	Straight Cage Trial, 9mm x 6°	1
3	72-PS-9508	Paddle Shaver, 8mm	1	22	72-TS-0610	Straight Cage Trial, 10mm x 6°	1
4	72-PS-9509	Paddle Shaver, 9mm	1	23	72-TS-0611	Straight Cage Trial, 11mm x 6°	1
5	72-PS-9510	Paddle Shaver, 10mm	1	24	72-TS-0612	Straight Cage Trial, 12mm x 6°	1
6	72-PS-9511	Paddle Shaver, 11mm	1	25	72-TS-0613	Straight Cage Trial, 13mm x 6°	1
7	72-PS-9512	Paddle Shaver, 12mm	1	26	72-TS-0614	Straight Cage Trial, 14mm x 6°	1
8	72-PS-9513	Paddle Shaver, 13mm	1	27	72-TS-1209	22mm Straight Cage Trial, 9mm x 12°	1
9	72-PS-9514	Paddle Shaver, 14mm	1	28	72-TS-1210	Straight Cage Trial, 10mm x 12°	1
10	72-DS-9505	Paddle Distractor, 5mm	1	29	72-TS-1211	Straight Cage Trial, 11mm x 12°	1
11	72-DS-9506	Paddle Distractor, 6mm	1	30	72-TS-1212	Straight Cage Trial, 12mm x 12°	1
12	72-DS-9507	Paddle Distractor, 7mm	1	31	72-TS-1213	Straight Cage Trial, 13mm x 12°	1
13	72-DS-9508	Paddle Distractor, 8mm	1	32	72-TS-1214	Straight Cage Trial, 14mm x 12°	1
14	72-DS-9509	Paddle Distractor, 9mm	1				
15	72-DS-9510	Paddle Distractor, 10mm	1				
16	72-DS-9511	Paddle Distractor, 11mm	1				
17	72-DS-9512	Paddle Distractor, 12mm	1				
18	72-DS-9513	Paddle Distractor, 13mm	1				
19	72-DS-9514	Paddle Distractor, 14mm	1				

SHURFIT® LUMBAR STRAIGHT INSTRUMENT TRAY

72-BK-070X

Bottom Level



#	Item No.	Description	Qty
1	72-CH-0001	Fixed 1/4" QC T-Handle	2
2	37-IN-0084	Mallet	1
3	72-RH-1000	Implant Remover	1
4	72-IN-2001	Straight Inserter	2
5	72-IN-9003	Straight Cage Tamp	1
6	72-IN-9004	Straight Cage Posted Tamp	1
7	72-SH-9000	Slap Hammer	1

SHURFIT® LUMBAR DISC PREP 72-BK-101X Top Level

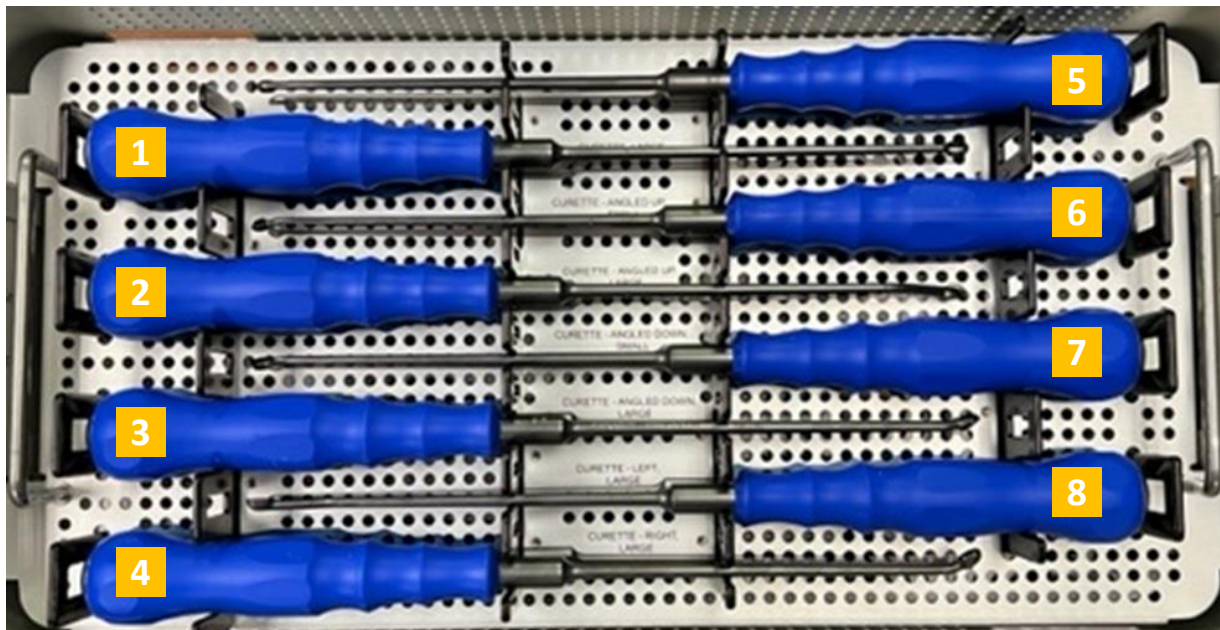

#	Item No.	Description	Qty
1	72-DC-0022	#4 Curette Straight, Serrated	1
2	72-DC-0032	#4 Curette Angled Up, 30°, Straight, Serrated	1
3	72-DC-0042	#4 Curette Angled Down, 30°, Straight, Serrated	1
4	72-DC-0052	#4 Curette, Right, Serrated	1
5	72-DC-0021	#2 Curette Straight, Straight, Serrated	1
6	72-DC-0031	#2 Curette Angled Up, 30°, Straight, Serrated	1
7	72-DC-0041	#2 Curette Angled Down, 30°, Straight, Serrated	1
8	72-DC-0051	#4 Curette, Left, Serrated	1

SHURFIT® LUMBAR DISC PREP 72-BK-101X Middle Level

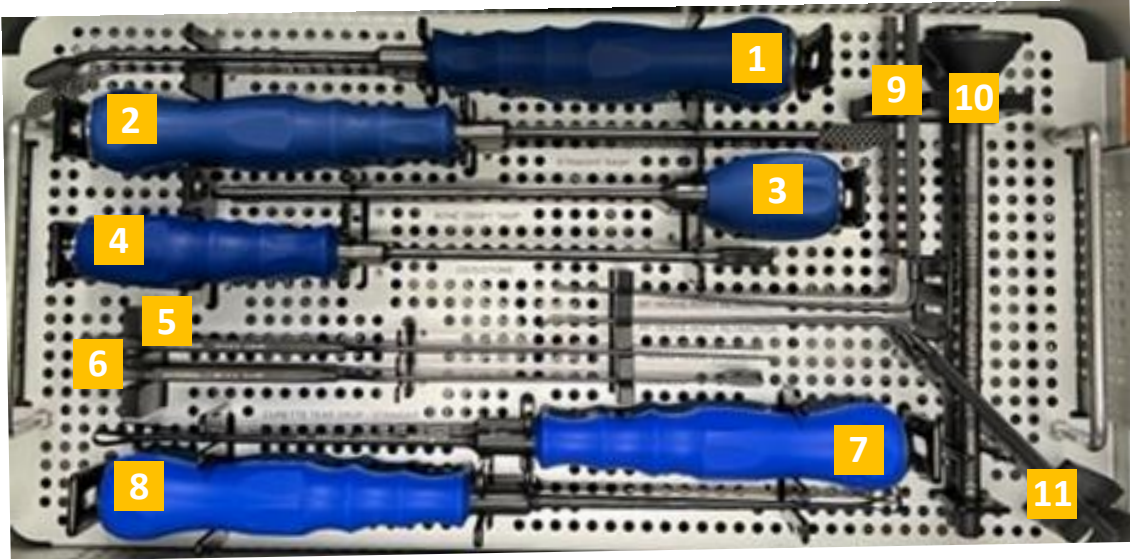

#	Item No.	Description	Qty
1	72-RS-9007	9mm Wide Rasp, Double Sided; Curved Rasp	1
2	72-RS-9006	9mm Wide Rasp, Double Sided; Straight Rasp	1
3	72-DP-0121	Bone Graft Tamp	1
4	72-DP-0130	8mm Wide Osteotome	1
5	72-DP-0101	45° Nerve Hook, Straight	1
6	72-DP-0091	Penfield, #4 Pull, Straight	1
7	72-DC-0011	Curette Tear Drop - Straight 8mm	1
8	72-DC-0012	Curette Tear Drop - Angle (30°) 8mm	1
9	72-DP-0002	90° Nerve Root Retractor	1
10	72-DP-0111	Bone Graft Funnel	1
11	72-DP-0001	45° Nerve Root Retractor	1

SHURFIT® LUMBAR DISC PREP

72-BK-101X

Bottom Level

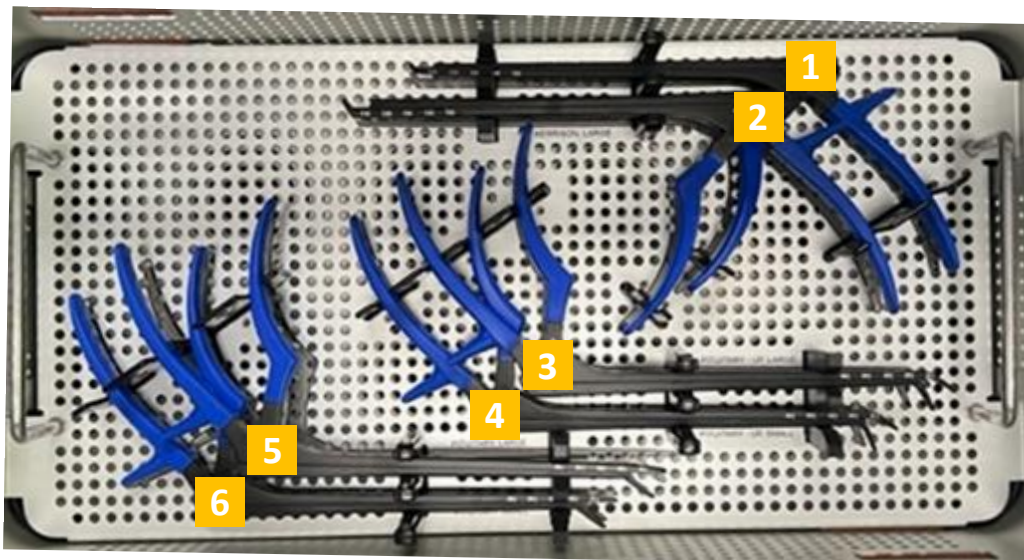

#	Item No.	Description	Qty
1	72-DK-0062	Kerrison, 40°, Straight, 2mm	1
2	72-DK-0064	Kerrison, 40°, Straight, 4mm	1
3	72-DP-0074	Pituitary - Up, Straight, 4mm	1
4	72-DP-0072	Pituitary - Up, Straight, 2mm	1
5	72-DP-0084	Pituitary - Straight, 4mm	1
6	72-DP-0082	Pituitary - Straight, 2mm	1

SURGICAL TECHNIQUE

The following technique describes the unilateral insertion of a single implant into the disc space through a posterior lumbar interbody fusion (PLIF) approach, transforaminal lumbar interbody fusion (TPLIF) approach or anywhere in between based on the pathology being addressed and surgeon preference. This technique may be performed through an open, less invasive or minimally invasive procedure.

Note: This surgical technique is intended as a guide only. It is recommended that the surgeon be thoroughly trained before proceeding. The surgeon must consider the particular needs of each patient and make the appropriate adjustments when necessary and as required. Please refer to the ShurFit 3D Titanium Interbody Cage Instructions For Use for complete information on indications, contraindications, precautions, warnings, potential adverse effects, sterilization and packaging

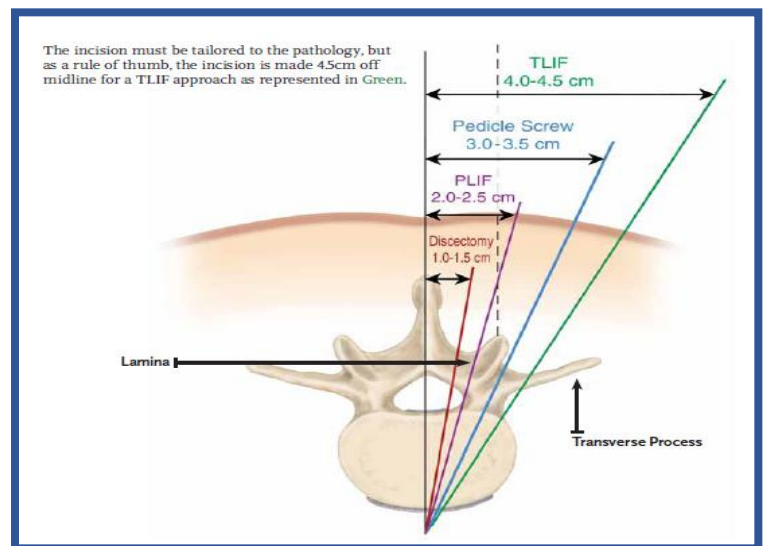

1 PATIENT POSITIONING

Place the patient in the prone position and drape in a manner consistent with surgical facility protocol. (Figure 1) Utilizing A/P and lateral fluoroscopic imaging and palpation of the patient anatomy, identify and mark the affected level.



Figure 1

SURGICAL TECHNIQUE

2

ENDPLATE PREPARATION

Create a skin incision at the targeted affected level(s) and dissect and retract the soft tissue.

Remove the inferior facet of the superior vertebrae with an osteotome, burr, or Kerrison. Expose and resect the capsular portion of the ligamentum flavum. Excise the superior facet of the inferior vertebrae with an osteotome, burr, or Kerrison. (Figure 2)

Repeat on the contralateral side for a bilateral PLIF.

Decompress the neural foramen and central spinal canal as necessary. Expose the posterolateral portion of the annular fibrosis and create an annular window to gain access to the intervertebral space.

Additional distraction can be achieved with Paddle Distractors (72-DS-95XX). (Figure 2a)

Securely attach the T-handle to the Paddle Shaver (72-PS-95XX). Utilize the Paddle Shaver to prepare the disc space and remove the superficial layers of the cartilaginous endplates. (Figure 2b)



Figure 2

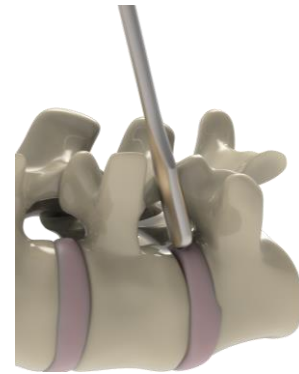

Figure 2a

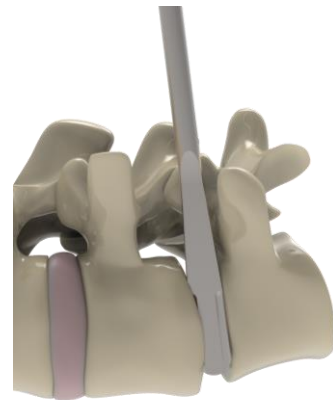

Figure 2b



Paddle Distractor
72-DS-95XX



Paddle Shaver
72-PS-95XX

SURGICAL TECHNIQUE

3 IMPLANT SELECTION

At the surgeon's discretion, posterior distraction of the vertebral space may be performed.

Insert the appropriate Trial (72-TS-XXX) into the annulotomy window and position within the disc space. (Figure 3)

Confirm proper positioning with A/P and lateral fluoroscopy.

Repeat the trial process until the desired amount of distraction is achieved within the disc space. The height and length of the implant are determined from the final Trial.

A Slap Hammer (72-SH-9000) may be used in positioning or removing the Trial.



Straight Cage Trial
72-TS-06XX
72-TS-12XX



Slap Hammer
(72-SH-9000)

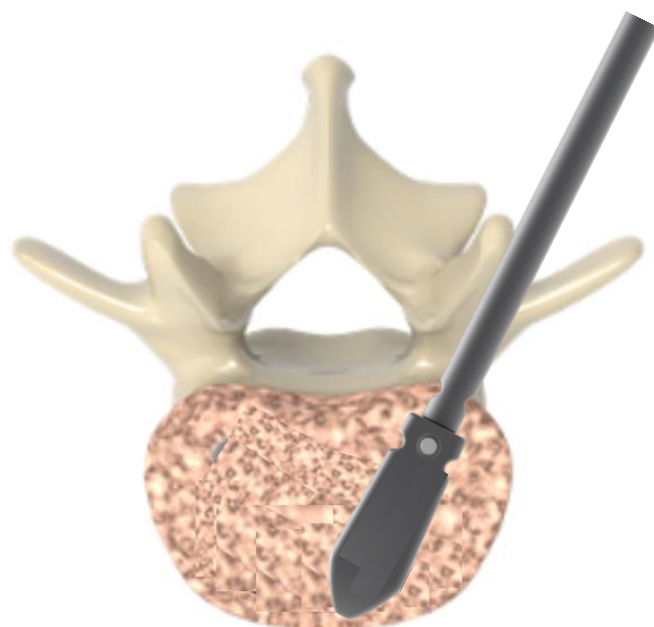
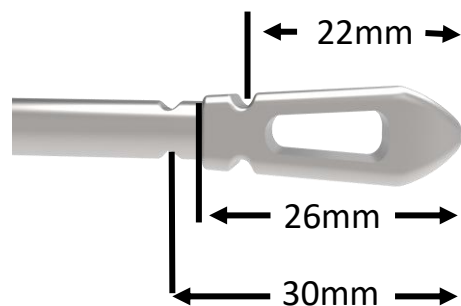

Figure 3

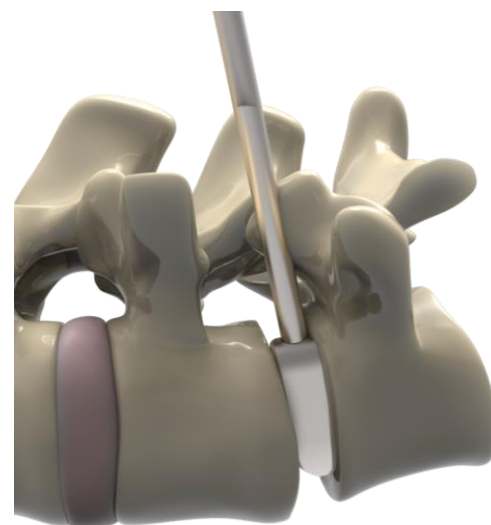

Figure 3 (Lateral)

SURGICAL TECHNIQUE

4

IMPLANT INSERTION

Based on the final Trial, select the appropriate size implant.

Insert bone graft material to the large window of the implant.

Press the Straight Inserter's (72-IN-2001) Gold Button and rotate the front knob counterclockwise to the UNLOCK position. (Figure 4)

Position the distal tips of the Inserter securely onto the sides of the implant. While holding the implant on the Inserter, rotate the front knob on the Inserter clockwise to the LOCK position to secure implant onto the Inserter. (Figure 4a)



Straight Inserter
72-IN-2001



Unlock



Lock

SURGICAL TECHNIQUE

4

IMPLANT INSERTION (cont.)

Insert the implant into the disc space. (Figure 4b)

Confirm proper positioning with A/P and lateral fluoroscopy.

Final position of the implant can be achieved using the Tamp.

Confirm final implant position via A/P and lateral fluoroscopy.
(Figure 4c)

To disengage the implant, press the gold button and rotate the front knob on the Inserter counterclockwise to the UNLOCK position.

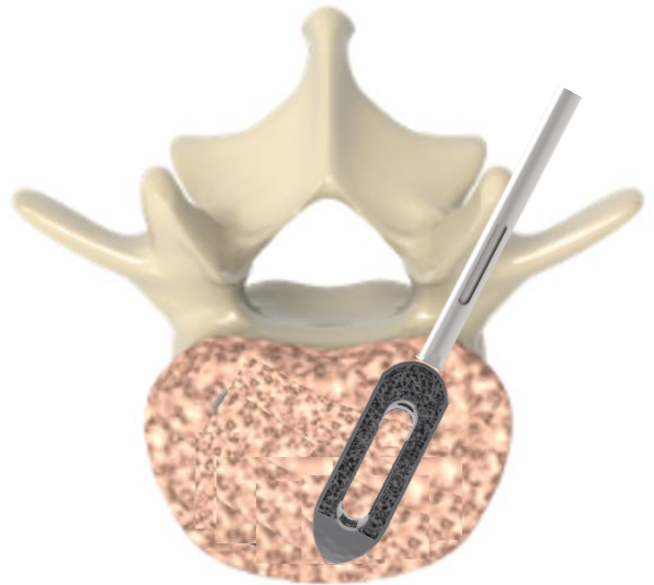

Figure 4b

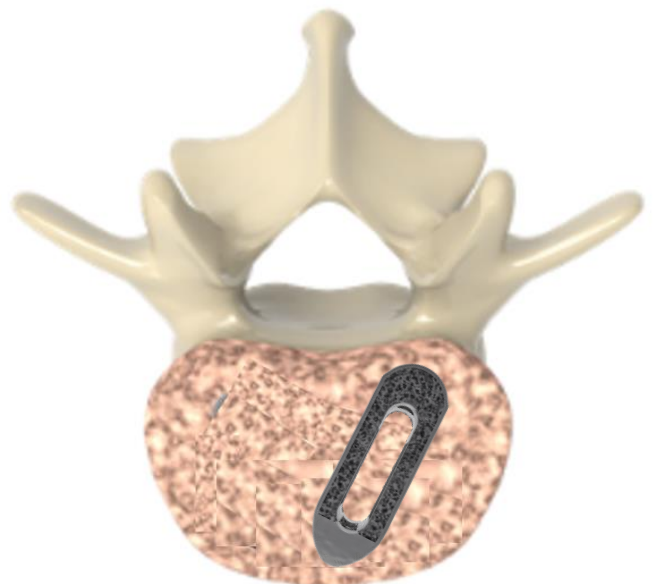

Figure 4c

SURGICAL TECHNIQUE

5

IMPLANT REMOVAL

If required, the implant can be removed using the Inserter and Slap Hammer. Rotate the Straight Inserter Front Knob to the Unlocked position. Place the distal tips of the Inserter securely onto the sides of the implant. (Figure 5) While holding the implant on the Inserter, rotate the Front Knob on the Inserter to the Locked position to tighten. Attach the Slap Hammer to the Inserter and remove the implant from the disc space. (Figure 5a)

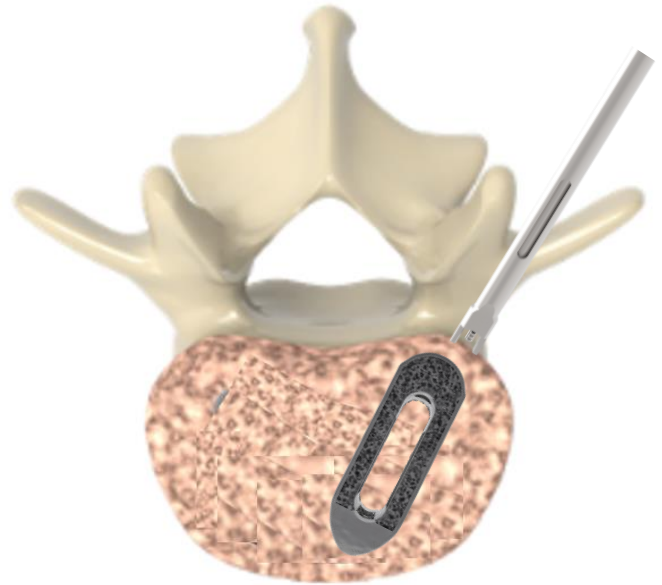

Figure 5



Figure 5a



Precision Spine, Inc.

2050 Executive Drive, Pearl, MS 39208

Customer Service: 1.888.241.4773

Phone: 601.420.4244

Toll Free: 877.780.4370

Fax: 601.420.5501

www.precisionspineinc.com

Caution: Federal (USA) law restricts these devices to sale by, or on the order of, a physician.
ShurFi® and Precision Spine® are trademarks of Precision Spine, Inc.
Copyright 2022 Precision Spine, Inc. All rights reserved. P/N LBL-STG-049 Rev A 3/2022

CE 2797